



Morek EV DC Charger Installation and Configuration Manual

ev.morek.eu

v_1.01.1

Contents





1. Safety Instructions.....	3
1.1 Symbols used in this manual	3
1.2 Save these instructions.....	3
1.3 WARNING: Risk of electric shock.....	3
1.4 WARNING: Accumulation of gases.....	4
1.5 CAUTION.....	4
1.6 Charging station safety precautions	4
1.7 Safety Labels on the packaging.....	5
2. Introduction	7
2.1 Important information.....	7
2.2 Scope of the Document	7
2.3 Product Introduction.....	8
2.4 Product Specification	9
2.5 List of Tools.....	10
3. Product Features.....	11
3.1 Product Parts	11
3.2 Nameplate.....	11
4. Transport and Storage	12
4.1 Storage	12
4.2 Transport.....	12
4.3 Packed Product Handling	12
4.4 Packaging Removal.....	13
4.5 Supplied Components	15
5. Preparation for Installation	16
5.1 Safety precautions	16
5.2 Plan installation.....	16
5.3 Select location.....	16
5.4 Parking space placement.....	16
5.5 Cooling.....	18
5.6 Implantation plan.....	19
5.6.1 Column installation	19

5.6.2 Wall mount installation.....	20
5.7 Route power supply cables.....	21
5.8 Protection against electric shock and short circuits.....	22
5.9 Electrical requirements.....	22
5.9.1 Upstream requirements.....	22
5.9.2 Grounding Instructions.....	23
6 Install Morek DC 30KW.....	24
6.1 Handling.....	24
6.2 Installing a cabinet.....	24
6.3 Open the door of Morek DC 30KW.....	24
6.4 Electrical Connections.....	25
6.5 Check after Installation.....	26
7. Commissioning.....	27
7.1 Preparation for Power on.....	27
7.2 power on the charging station.....	27
8. Use of Morek DC 30KW.....	28
8.1 Start Charging.....	28
8.1.1 Local start.....	28
8.1.2 Remote start.....	31
8.2 Stop charging.....	32
8.2.1 Local stop.....	32
8.2.2 Remote stop.....	33
8.3 Charging by online or offline.....	34
9. Decommissioning.....	37
10. Preventive Maintenance.....	38
11. Troubleshooting.....	39

1. Safety Instructions

Read and observe the following safety precautions before you install, service, or use your Morek charging station. The installer must ensure that the charging station is installed in accordance with the relevant country-specific standards, and local regulations.

1.1 Symbols used in this manual

Symbol	Explanation
	DANGER: Indicates an imminently hazardous situation with a high risk of level which, if the danger is not avoided, will cause death or serious injury.
	WARNING: Indicates a potentially hazardous situation with moderate risk level which, if the warning is not obeyed, can cause death or serious injury.
	CAUTION: Indicates a potentially hazardous situation with a medium risk level which, if the caution is not obeyed, may cause minor or moderate injury or damage to the equipment.
	Note: Notes contain helpful suggestions or references to information not contained in the manual.

1.2 Save these instructions

This manual contains important instructions for Morek DC30kW Charging Station that need to be followed during installation, operation and maintenance of the unit.

1.3 **WARNING: Risk of electric shock**

- Switch off input power to your charging station before you install or service the charging station. Keep the power off until the charging station is fully installed with its covers secured.
- In the event of danger and/or an accident, a certified electrician must immediately disconnect the charging station from the electrical supply.
- Do not operate the charging station if it is physically damaged or if the charging cable has cracks, excessive wear, or other visible damage. Contact Morek or your distributor if you suspect that the charging station is damaged.
- Do not direct powerful jets of water toward or onto the charging station. Never operate it with wet hands. Do not put the EV charging plug into any liquid.
- Do not place fingers or other objects inside the charging port or plug port.
- Read the user instructions delivered with your Morek charging station and the User Manual for your electric vehicle before charging.

1.4 WARNING: Accumulation of gases

Some electric vehicles require an external ventilation system to prevent the accumulation of hazardous or explosive gases when charging indoors. Refer to your vehicle User Manual to check if your vehicle releases hazardous or explosive gases when charging.

1.5 CAUTION

- Use this charging station to charge compatible electric vehicles only. Refer to your vehicle user manual to check if your vehicle is compatible.
- This charging station may affect implanted electronic medical devices. Before you charge your vehicle, consult the supplier of the electronic medical device to determine if it can be affected by charging effects.
- This charging station contains no user-serviceable parts. The user must not attempt to service, repair, or relocate the charging station. Contact Morek or your distributor for more information.
- Make sure that the charging cable cannot be damaged (kinked, jammed, or driven over) and that the plug(s) do not come into contact with heat sources, dirt, or water.
- Only use the charging station under the specified operating conditions.
- Do not use explosives or flammable substances near the charging station.
- If you are unsure about how to use a charging station, ask for help.
- Do not allow children to operate a charging station. Adult supervision is required when children are near a charging station that is in use.
- Adapters, conversion adapters, or cord extensions must never be used on this charging station.

1.6 Charging station safety precautions



CAUTION:

Do not open the charging station doors when:

- It is raining, snowing.
- The charging station is exposed to direct sunlight.
- Weather conditions are wet (fog, ...).

Failure to follow these instructions can result in danger to the user and may void the warranty and liability.



CAUTION:

Electrostatic discharge.

This device contains components that can be damaged or destroyed by electrostatic discharge.



- When handling this device, observe the necessary safety measures regarding electrostatic discharge (ESD) according to EN61340-5-1 and 61340-5-2.



**CAUTION:**

- This charging station must be stored and transported according to the specifications described in this manual.
- Even if the charging station can be used by a non-qualified person, the charging station may only be installed, commissioned, serviced, relocated, repaired and decommissioned by qualified persons. Failure to follow these instructions can result in danger to the user and may void the warranty and liability.
- Modification of the product is prohibited. It can result in danger to the user and may void the warranty and liability.
- This charging station contains no user-serviceable parts. The user must not attempt to service, repair, or relocate the charging station. Contact Morek or your distributor for more information.
- Make sure that the charging cable cannot be damaged (kinked, jammed, or driven over) and that the plug(s) do not come into contact with heat sources, dirt, or water.
- Only use the charging station under the specified operating conditions.
- Do not use explosives or flammable substances near the charging station.
- Do not use peripherals, consumables or accessories that do not conform or are unsuitable for the charging station.
- Do not use anti-graffiti treatment that may damage the charging station.
- Do not modify the features of the charging station (data settings, cabling, ...).
- This charging station must be protected against animals, object intrusion or water ingress even if they do not alter charging station operation.

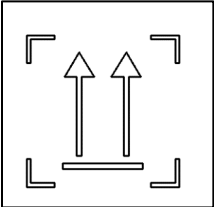
Failure to follow these instructions will result in damage to the charging station.

1.7 Safety Labels on the packaging

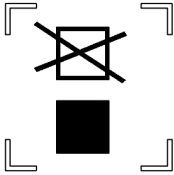
Label	Location	Description
	On the packaging	Caution The direction indicated by the arrow is upward;
	On the packaging	Caution The package contains fragile items, please handle with care;

	<p>On the packaging</p>	<p>Caution</p> <p>Packaging and internal items shall be protected from rain and moisture.</p>
	<p>On the packaging</p>	<p>Caution</p> <p>Packaging is prohibited from stacking</p>
	<p>On the packaging</p>	<p>Warning</p> <p>Keep upright!</p>
	<p>On the packaging</p>	<p>Warning</p> <p>Handle with care</p>

2. Introduction

This Installation and User Manual outlines the installation requirements and steps for Morek DC30kW charging station, as well as how to use the station.



CAUTION:

This equipment is not intended for use in residential environments and may not provide adequate protection to radio reception in such environments.

2.1 Important information

The document is produced for information purposes only and does not constitute an offer binding upon Morek. Morek has compiled the contents of this document to the best of its knowledge. No express or implied warranty is given for the completeness, accuracy, reliability, or fitness for particular purpose of its content and the products and services presented therein. Specifications and performance data contain average values within existing specification tolerances and are subject to change without prior notice. Prior to ordering, always contact Morek for the latest information and specification. Morek explicitly waives liability for any direct or indirect damage, in the broadest sense, arising from or related to the use and/or interpretation of this document. ©Morek. All rights reserved.

2.2 Scope of the Document

Keep this manual for the entire lifetime of Morek DC30kW charging Station.



CAUTION:

This manual is intended as a resource for qualified personnel with experience in working on High Voltage projects who are capable of identifying the requirements and taking all necessary precautions to safely complete a Morek DC 30KW installation.

© 2023 Morek - all rights reserved. No part of this document may be modified, reproduced, processed, or distributed in any form or by any means, without the prior written permission of Morek.

2.3 Product Introduction

Morek DC 30kW EV charging station optimizes the use of space by charging up to vehicles simultaneously using CCS2.

User friendly design with 7" touch screen.



2.4 Product Specification

AC INPUT	Input Voltage	3-phase+neutral+PE 400VAC \pm 10%
	Input Current	0~58A
	Frequency	50Hz
	Power Factor	\geq 0.99
	Input THDi	\leq 5%
DC OUTPUT	Output Voltage	150~1000V
	Output Power	30KW
	Output Current	0~100A
	Voltage Regulation Accuracy	$\leq\pm$ 0.5%
	Current Regulation Accuracy	$\leq\pm$ 1%
	Charging Type	MODE 4 ; CASE C
	Power Limiting	Available
Features	Efficiency	\geq 95%
	IP Level	IP54
	IK Level	IK10
	Charging Access	RFID Card/APP/QR code/Credit Card (optional)
	Screen	7" Touchable LCD
	Standard	EN IEC 61851-1/EN IEC 61851-23 /EN IEC 61851-24 /EN IEC 61851-21-2/DIN 70121
	Connector	CCS Combo 2 *1
	Cable Length	4.5m
	Ambient Temperature	-25 $^{\circ}$ C~50 $^{\circ}$ C
	Relative Humidity	5%Rh~95%Rh
	Altitude	\leq 2000m
	Dimensions	\leq 600*260*750mm
	Mass	\leq 71 kg
	Installation	Wall mount
	Communication Protocol	OCPP1.6J
	Optional	POS, PTB meter, Column
Protection	Input Over-Voltage Protection	Available
	Input Low-Voltage Protection	Available
	Output Over-Voltage Protection	Available
	Short-Current Protection	Available
	Over-Current Protection	Available

2.5 List of Tools



CAUTION:

Some operations described in this manual may require a ladder or a stepladder.

Refer to your local regulation regarding the working height and relevant safety instructions.

Below is the list of the tools required (not included) to install Morek DC30kW charging station:

- Needle nose pliers
- Utility knife
- Phillips screwdriver
- M12*100 expansion screw
- Percussion drill + ϕ 12 drill
- Afterburner lever
- 13# ratchet wrench
- 18# ratchet wrench

The connecting point of the EV supply equipment shall be protected by an RCD having a rated residual operating current not exceeding 30 mA, RCD(s) protecting connecting points shall be at least type A, Rated voltage 400V, rated current at least 80A. You need to add AC molded case circuit breaker with leakage protection function in the front of single equipment.

3. Product Features

3.1 Product Parts

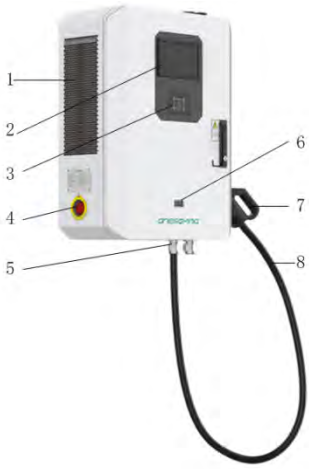
Illustration	Description
	<ol style="list-style-type: none">1. Air outlet grille2. Capacitive touch screen3. Swipe area4. Emergency stop button5. Stainless steel metal lock head6. Visible window(PTB meter display window depending on the configuration, Optional)7. Charging connector (CCS2)8. Charge cable

3.2 Nameplate

The nameplate is located at the bottom of the left side.

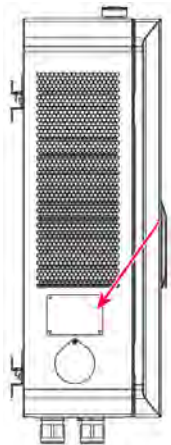

4. Transport and Storage

4.1 Storage



WARNING:

Condensation inside the cabinet damages the charger.

- Only transport and store the charging station in its original packaging. No liability can be accepted for damage incurred when the product is transported in non-standard packaging.
- Store the charging station away from exposure to the sun and in a dry environment in the temperature range stated in the specifications.
- Disconnect input power before removing the charging station for storage or relocation.

Failure to follow these instructions will result in waiver of warranty and product damage.

4.2 Transport



WARNING:

Damaged product

After any transportation, make a detailed visual inspection of the charger with its packaging opened. Reject the product if there is any visible damage. Make all damage claims to the transport operator immediately and also immediately inform the sender regarding transport insurance.

Failure to follow these instructions can result in death, serious injury or equipment damage.

Visual inspection

Check if:

- The exterior packaging has been damaged.
- The exterior panels of the charger are damaged (shock, scratch, ...).
- The doors are working properly.
- The interior of the charger is clean and undamaged

4.3 Packed Product Handling

1. Handling with a forklift

Handle the packed product with a forklift (No more than 3 units on the pallet).

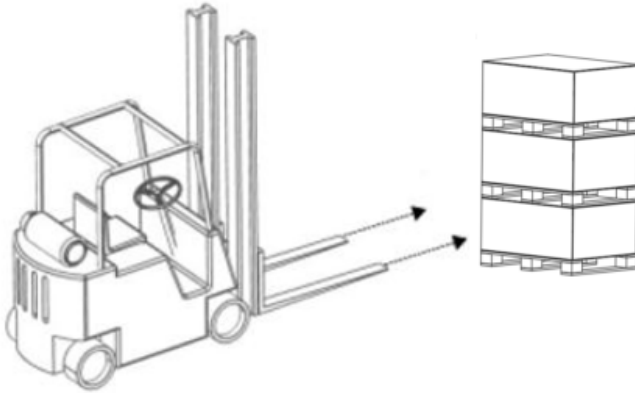

2. Manual Materials handling

Two persons are required to move one cabinet at a time.

4.4 Packaging Removal



CAUTION:

Some operations described in this manual may require a ladder or a stepladder.

Refer to your local regulation regarding the working height and relevant safety instructions.

1. Remove the metal clips that hold the wooden package.

Tools: needle-nose plier and an iron crowbar.

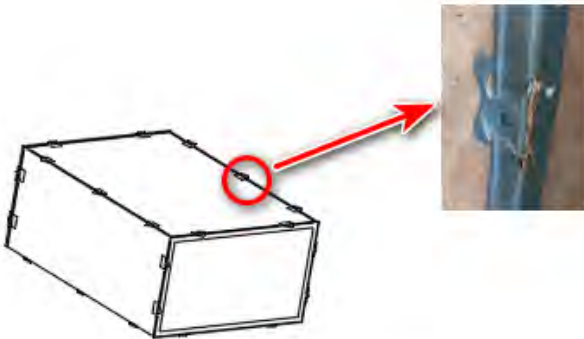

2. Put them aside.

3. Remove the roof cover

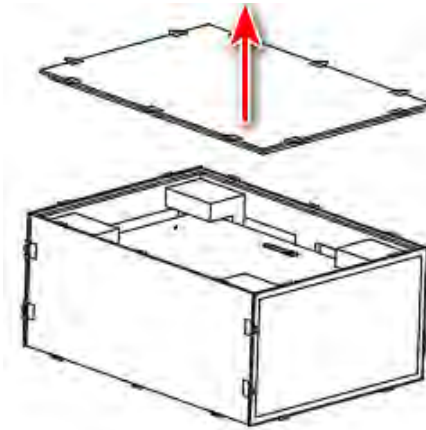

4.Remove the left and right side covers.

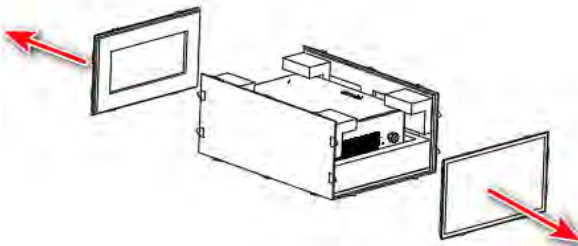

5.Remove the front and back covers.

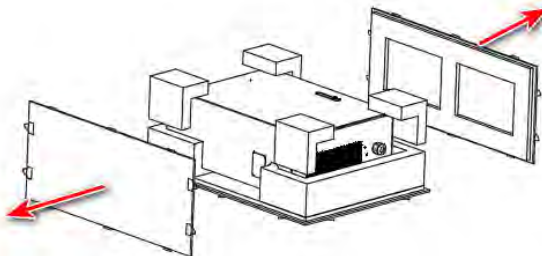

6.Remove the wrapping film wrapped around the cabinet.

7.Remove the PE plastic bag over the cabinet.

8.Remove the EPE cushioning blocks around the cabinet.

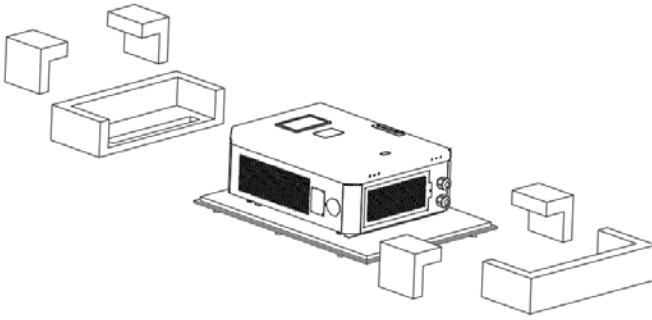

4.5 Supplied Components

The packaging includes the following components:

- Charging station
- Accessories

5. Preparation for Installation

The following recommendations are intended as a guide to help you prepare for the installation of Morek DC30kW charging station.

5.1 Safety precautions

You must read and observe the Safety instructions on page 3 at the beginning of this manual before you install, service, or use Morek DC30kW charging station. The installer must ensure that the charging station is installed in accordance with the relevant country-specific standards and local regulations.

5.2 Plan installation

- Calculate the existing electrical load to determine the maximum operating current for the charging station installation.
- Calculate the distance from the local power supply panel to the charging station installation to find the voltage drop. Local regulations may apply and can vary depending upon the region or country.
- Obtain all necessary permits from the local authority that has jurisdiction.
- PE grounding connectors must be not spliced.
- Refer to local regulations, maximum current and voltage drop to select the conductor sizes.
- Use the correct tools and ensure sufficient material resources and protection measures.
- Make sure that there is good cellular reception where the charging station will be installed.
- Prepare the installation areas with the correct power wiring and data cabling.
- Prepare the upstream electric switchboard according to local regulations and Morek recommendations in Upstream requirements on page 23.

Ethernet network

To connect several Morek DC30kW charging station (for network sharing), it is necessary to install an Ethernet network.

5.3 Select location

The charger is intended for outdoor or indoor areas.

Position the charging station, where possible, in surroundings where it is not exposed to extreme sunlight and vulnerable to external damage.

The charger is intended for location in a non-restricted area.

5.4 Parking space placement

To achieve the maximum cable length, it is recommended to place Morek DC 30KW as described below.



Note:

Leave adequate free space in front of the charging station to ensure that users can interact with the touchscreen and other interfaces safely and comfortably.



Note:

Leave at least 600 mm on both side of the charger in order to ensure the connector is accessible.

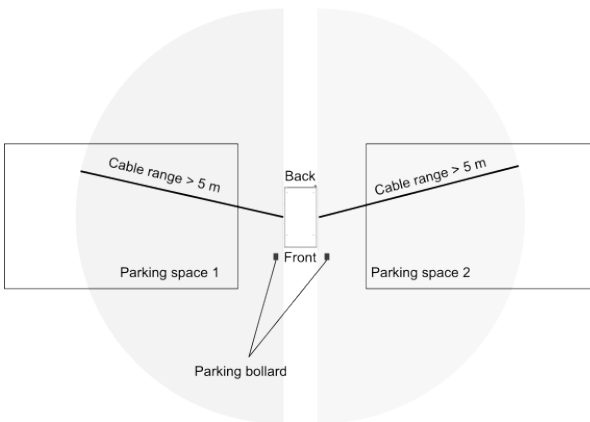
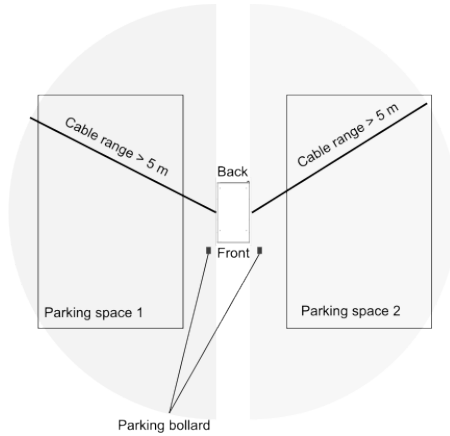

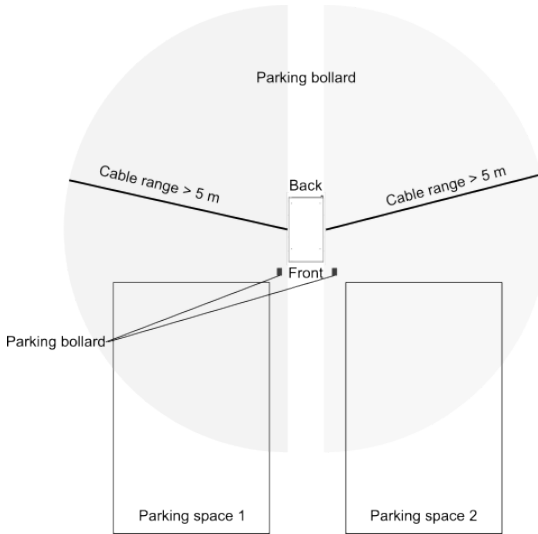

Note:

Bollards should not interfere with the clearance around the charger.

5.5 Cooling

The air inlet is located at the bottom of the cabinet, and the air outlet is located on the left side of the cabinet.

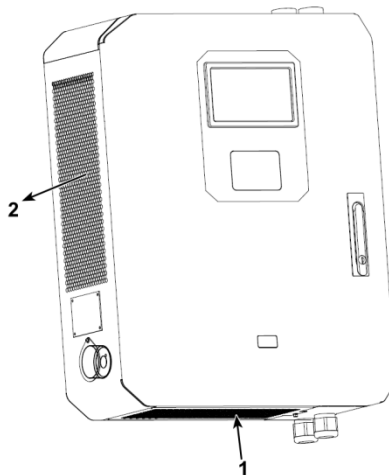

1. Air inlet; 2. Air outlet



Note:

In locations with harsh weather conditions (high temperatures, snow, strong sun conditions,...), it is recommended to ensure additional protection such as canopy or roof protection.

5.6 Implantation plan

5.6.1 Column installation

The opening size of the equipment is shown in the figure:

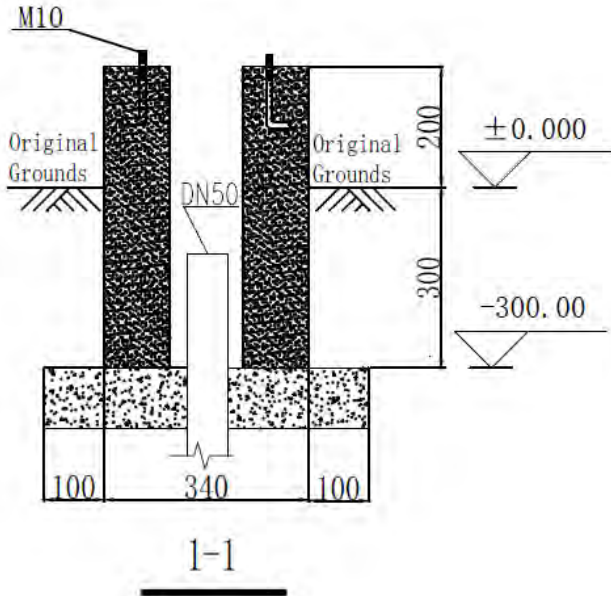
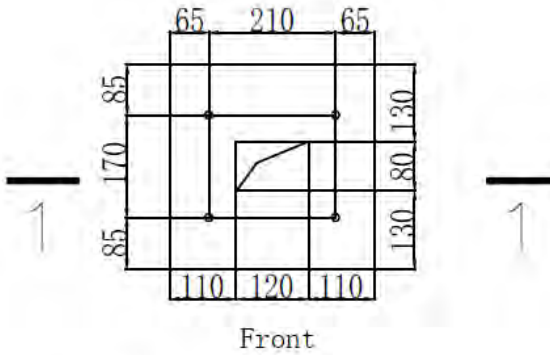

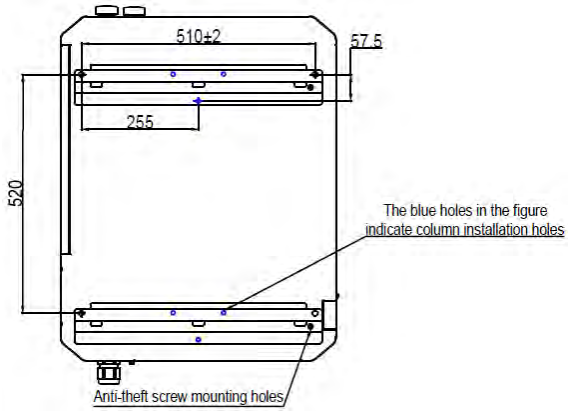
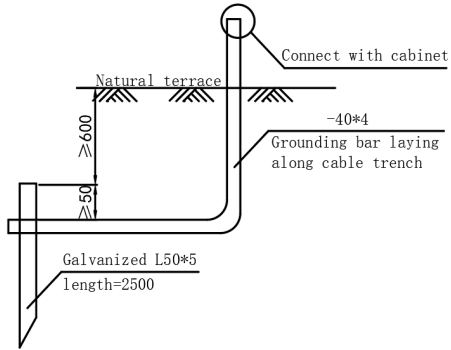

5.6.2 Wall mount installation

The opening size of the equipment is shown in the figure:

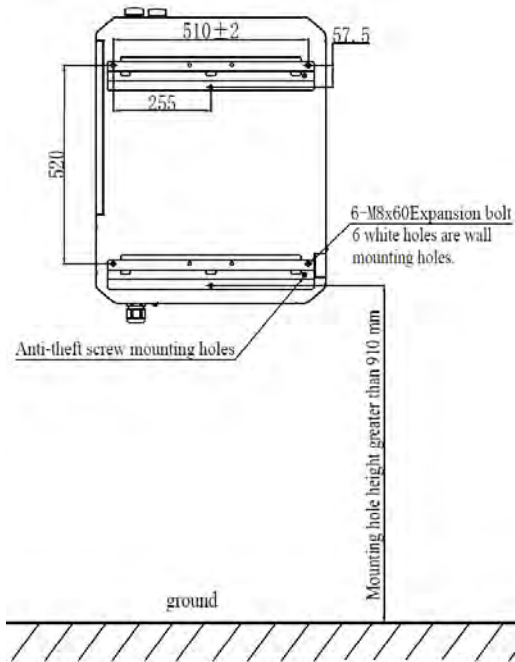

Explanation:

1. The installation position of the charging pile shall be determined according to the site
2. M8 stainless steel expansion bolt (length not less than 60mm), it must be perpendicular to the foundation surface, and ensure that 3 to 4 silk teeth are exposed after the nut is tightened.
3. All dimensions in the figure are in mm.
4. Matters not mentioned in the drawing shall be carried out according to the current national norms.
5. The distance between the front door of the equipment and the obstacle is not less than 0.8m, and the distance between the left and right sides and the wall is not less than 0.8m.

5.7 Route power supply cables

Prepare the cable and use standardized cable only. For AC cable, we suggest using cable size is $3 \times 25 + 2 \times 16 \text{ mm}^2$. AC cable size depends on system configuration and local regulations. Refer to electrical installation drawings or discuss with electrical designer for further information.



Note:

- Adaptors or conversion adaptors are not allowed to be used.
- Cord extension sets are not allowed to be used.

5.8 Protection against electric shock and short circuits

Protection against electric shock

The charging station contains the following devices to protect against electric shock:

- IMD (Insulation Monitoring Device). On outlet CCS2.
- Surge protector
- MCB for AC Input
- Leakage protection device for AC input

The following device is not included in the unit and must be installed in the switchboard upstream:

- Refer to local regulations, maximum current and voltage drop to select the device against electric shock in switchboard upstream.

Short circuit protection

The charging station contains the following devices to protect against short circuit:

- CCS2 outlet is protected by fuse.

5.9 Electrical requirements

5.9.1 Upstream requirements

Charging station

Electrical connection must be carried out by a professional electrician according to the local regulations.

Charging station must be connected to an electrical network with the following characteristics:

- 3 Phases (3P + PE +N*) (*Neutral required in case of AC socket).
- 400 Vac +/- 10%
- 50/60 Hz

The main switch disconnecter, located upstream of the charger power supply, must be rated by the installer.

Refer to local regulations, maximum current and voltage drop to select the upstream protection.



Note:

A RCD 30mA type A is required as minimum.

5.9.2 Grounding Instructions

Observe the following rules for the grounding instructions:

- Ground impedance must be lower than 20 ohms in dry conditions where the charging station is installed.

6 Install Morek DC 30KW

6.1 Handling

6.2 Installing a cabinet



WARNING:

- Always transport the charger in an upright position.
- Do not manipulate the charger when it is connected to the power supply.
- Do not use a crane type hoist that is unable to support the weight of the charger.
- The center of gravity of the charger is high, take care when handling.
- Do not place your hand underneath the charger or inside the feet through the side openings.
- The charger must be protected against overturning. This protection must be maintained until final mounting.

Wall-mounted installation: Mark the center position of each mounting hole on the wall according to the wall-mounted construction drawing of a 30kW cabinet. Use a $\varnothing 12$ drill bit to drill a 45mm deep mounting hole at the marked point, remove dust from the hole, and insert an expansion tube (M8*60) into the mounting hole. Install cabinet mounting ears on the wall according to the holes, and secure them using the nuts delivered with expansion bolts. Lift the 30kW wall hanging cabinet, align the upper and lower projecting parts of the cabinet with the long holes above the mounting ears on the wall, and place the cabinet into the cabinet. Open the cabinet door and install the M6 bolts and washers in the accessories to the place marked with anti-theft screws.

Vertical column installation: Mark the center of each mounting hole on the concrete floor according to the opening size of the 30kW vertical column base. The embedded M10*100 bolts should be perpendicular to the foundation surface and the exposed length should be 30mm. If an expansion screw is used, drill a diameter of 70mm deep into a hole with a diameter of 12 drill bits at the marked point, remove dust from the hole, insert an expansion tube (M10*100mm) into the hole, and secure it with M10 nuts.

After the cabinet is installed, shake the cabinet from different directions. Do not feel obvious loosening or shaking.

6.3 Open the door of Morek DC 30KW



CAUTION:

When opening the door, please follow the instruction next to the door lock.

Failure to follow this instruction will result in visible damage to the product.

Tool: Door Key

Locate the handle.

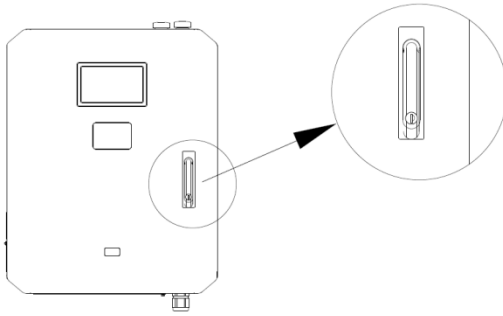

Open the door

1. Use the key to open the lock.
2. Pull out the handle
3. Turn the handle clockwise
4. Open the door



6.4 Electrical Connections

The steps to connect the cable are as follows:

1. Open the front door of the cabinet;
2. Ensure that the front switch of the cable is powered off to prevent electric shock;
3. Securely connect one end of the grounding cable to the grounding copper bar;
4. Connect AC input three-phase cables L1, L2 and L3 to input copper bars A, B and C respectively; The N wire is connected to the N wire copper bar.

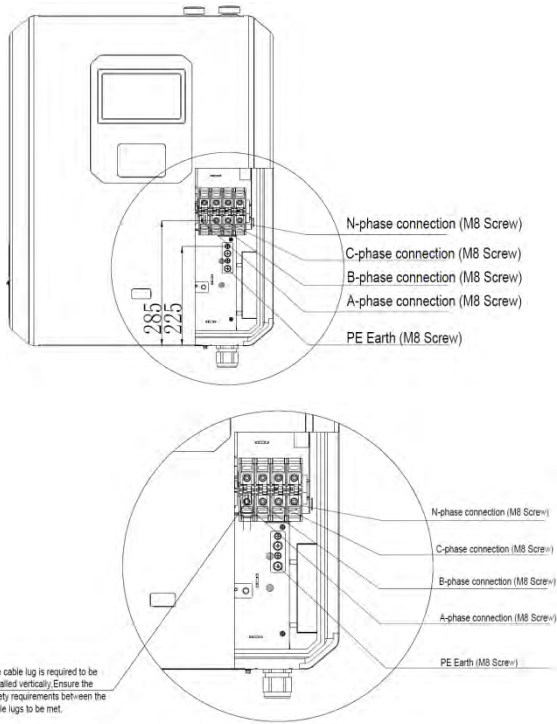

Partial enlargement, ratio 2:1

6.5 Check after Installation

1. Sealing

According to the requirements of the design and protection level, After the AC cable is installed, lock the cable lock to prevent dust or bugs from entering.

2. Clean up

Clean up the sundries inside the cabinet and around the cabinet, such as cables, binding tapes, screws, etc. Do not leave installation tools on site or in the cabinet.

3. Check

Check whether the base is firmly installed;

Check whether the electrical connections and cables are correct and complete, whether the connections are reliable, and whether the grounding is reliable;

Check appearance, marking, cleanliness.

7. Commissioning

Danger: Risk of Electric Shock



DANGER:

Risk of electric shock.

Before servicing, switch off the power at the main breaker (outside of the breaker) and switch off MCB in AC power supply system

and make sure the voltage is 0V.



Note:

The unit must be properly assembled in accordance with the assembly instructions.

Operation of power on the charging station

During operation, pay attention to the danger of high voltage to avoid personal injury and property damage. The system must be well grounded before power-on. An installation check must be carried out before commissioning. Confirm that the main AC input switch Q1 and circuit breakers Q3 are disconnected, and the charging gun head is on the cabinet body, and ensure that all devices are installed in place.

7.1 Preparation for Power on

Make sure that the upstream power supply switch of the charging system is disconnected;

Use a multimeter to confirm that there is no short circuit between the AC input L1\L2\L3\N\PE;

Use a multimeter to measure and confirm that there is no short circuit between DC+\DC-\PE of the two charging gun heads;

Connect the upstream power supply switch of the system;

Use a multimeter to measure that the three-phase input power supply voltage in the charging system cabinet is within the allowable working voltage range of the system (323VAC ~ 460VAC).

7.2 power on the charging station

Connect the AC input general MCB Q1 of the charging system;

Connect the circuit breakers Q3 of the front cabinet door of the charging system, and close the front door ;

After 2S, the system will automatically pull in the AC input contactor after the system self-check is normal, and the power module is electrified.

8. Use of Morek DC 30KW

The charger can be used by ordinary people (no special qualification or training is needed).

The owner of the charging station shall provide to the customer with all the procedure, security and warning related information.



WARNING:

Risk of electric shock:

- Do not operate the charging station if it is physically damaged or if the charging cable has cracks, excessive wear, or other visible damage. Contact Morek or your distributor if you suspect that the charging station is damaged.
- Do not direct powerful jets of water toward or onto the charging station. Never operate it with wet hands. Do not put the EV charging plug into any liquid.
- Do not place fingers or other objects inside the charging port or plug port.
- Read the user instructions supplied with your Morek charging station and the User Manual for your electric vehicle before charging.
- Make sure that the charging cable cannot become damaged (kinked, jammed, or driven over) and that the plug(s) do not come into contact with heat sources, dirt, or water.
- When the cable is connected on the charging station, do not leave the cable lying around on the floor.

8.1 Start Charging

8.1.1 Local start

Take off the connector and connect it to the vehicle, it will display:

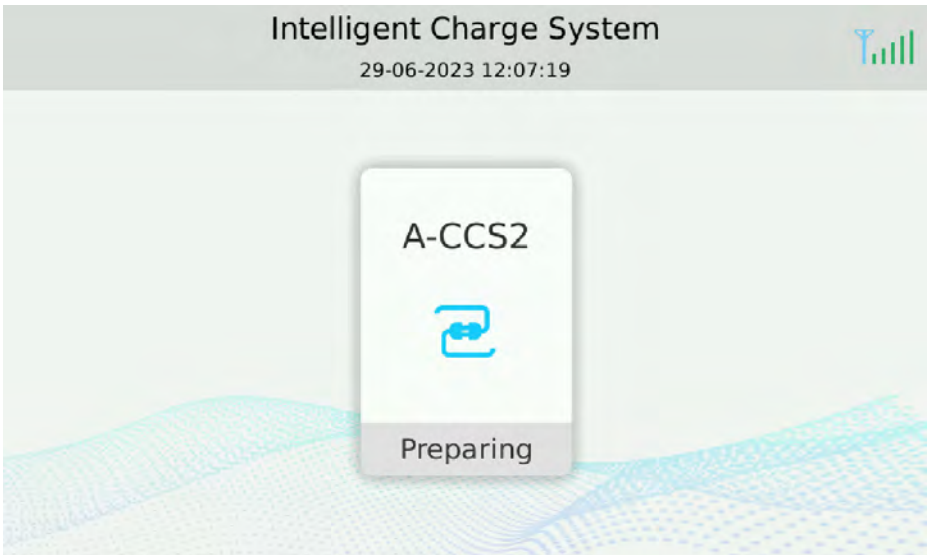

Click on “Preparing”.it display as follow:

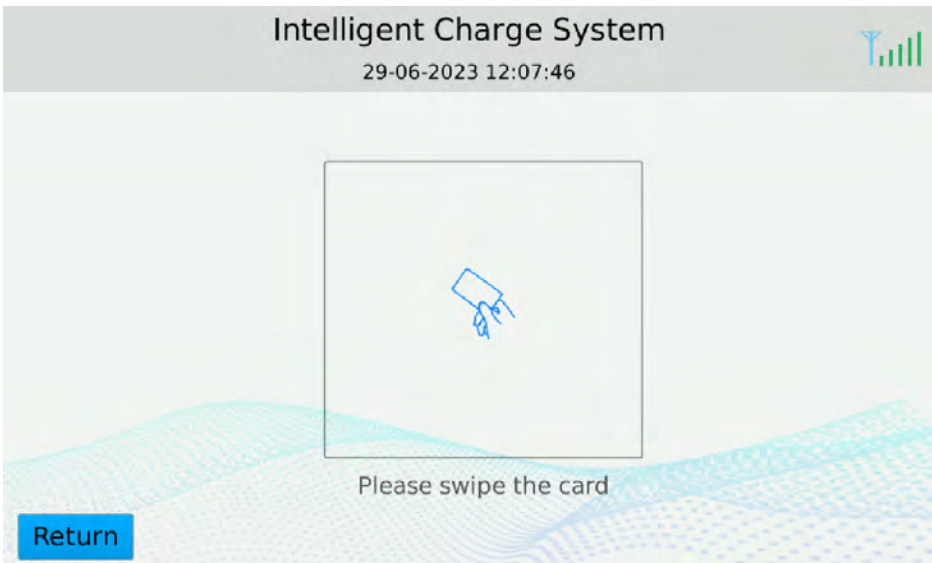

Swipe the RFID card to start charging, and the screen shows:

After verification is failed, it will display:

Intelligent Charge System



5



Verification failed. Please confirm and try again ...

After verification is successful, it will display:

Intelligent Charge System



5



Verification succeed. Please wait ...

After local verification is successful, it will display:

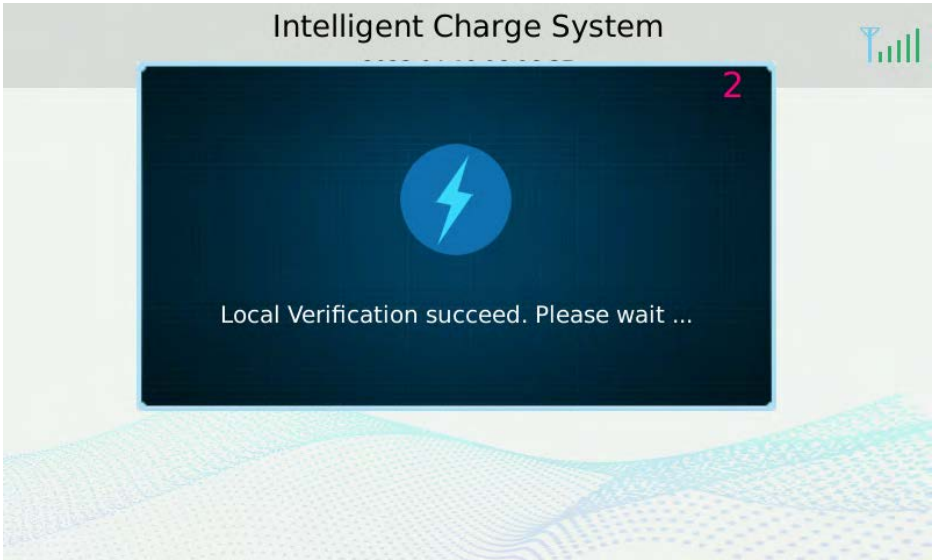

The charging station starts to charge the vehicle.

8.1.2 Remote start

The backend could give command of start charging after the charger is connected to it

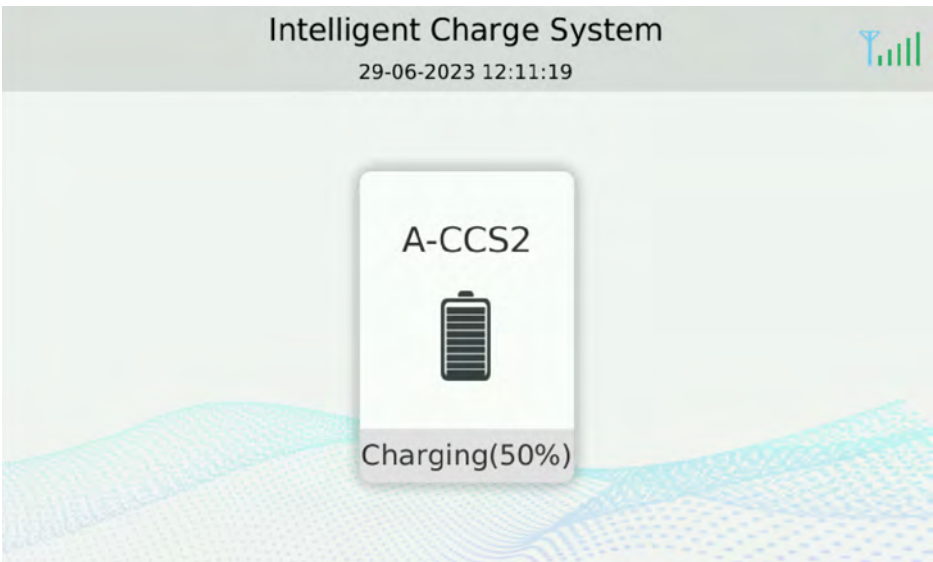

8.2 Stop charging

8.2.1 Local stop

Click on the charging button.

The charging information pops out and swipe the card again to stop charging process.

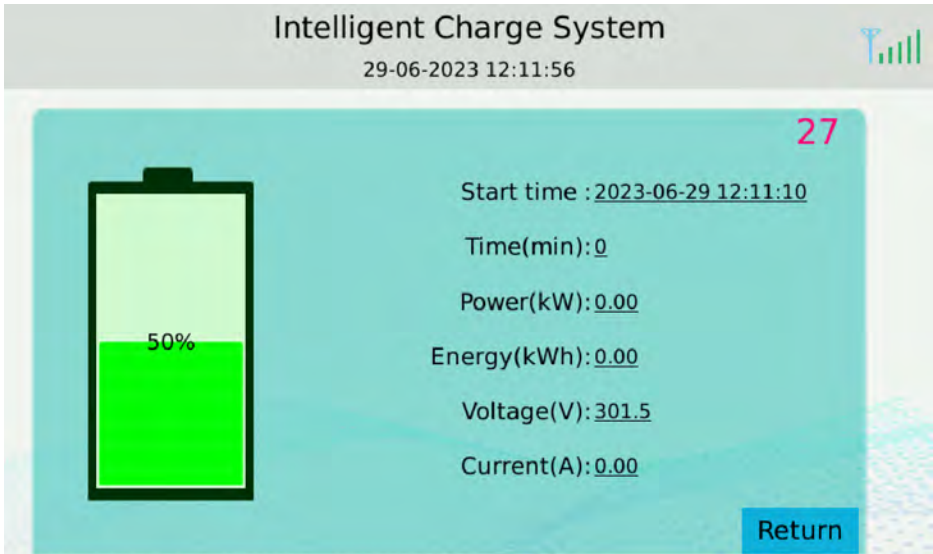

Stop charging. Please wait.



The screen returns to main menu and shows charging finished.

Intelligent Charge System

29-06-2023 12:12:25



A-CCS2



Finishing

To check the information of charging, you may click the “Finishing” button and scan them.

Put back the connector to its origin position after charging.

8.2.2 Remote stop

Charging finished after backend gives command of stop charging. Displayed as follows. To check the information of charging, you may click the “Finishing” button and scan them.

Intelligent Charge System

29-06-2023 12:12:32



You can start charging with another plug-in.

26

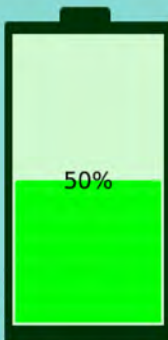

Initial SOC: 4%

Start Time: 2023-06-29 12:11:10

Stop Time: 2023-06-29 12:12:19

Charging energy: 0.00kWh

Charging time: 1min

Termination code: 99

Return

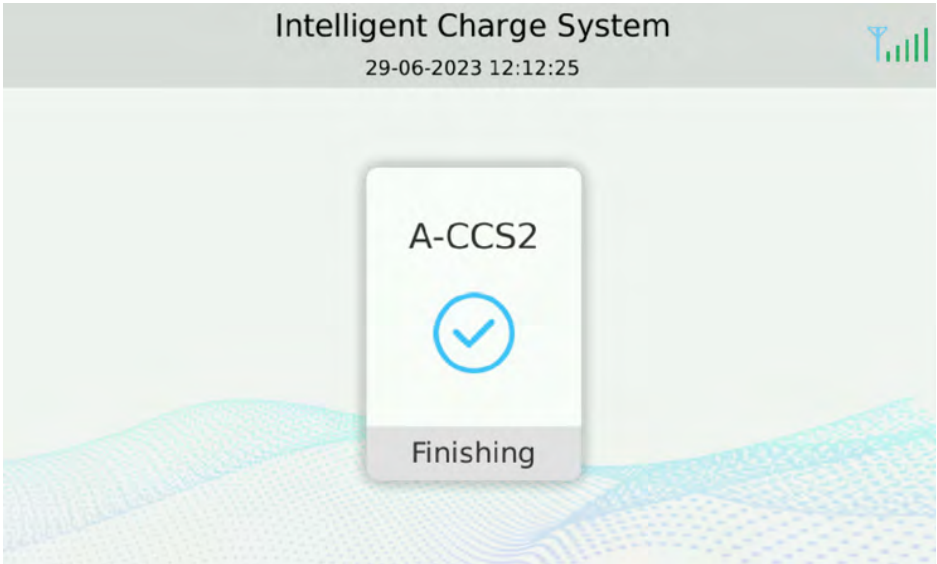

Put back the connector to its origin position after charging.

8.3 Charging by online or offline

The default charging mode of the charging station is offline. Under the offline function, you can use the M1 card to start the device; online function can use 4G communication method .

The specific operations are as follows:

Click on the blank space at the upper left of the screen, the login interface appears, enter the password '301204', click 'Enter', and click 'Login' to enter the settings main interface.

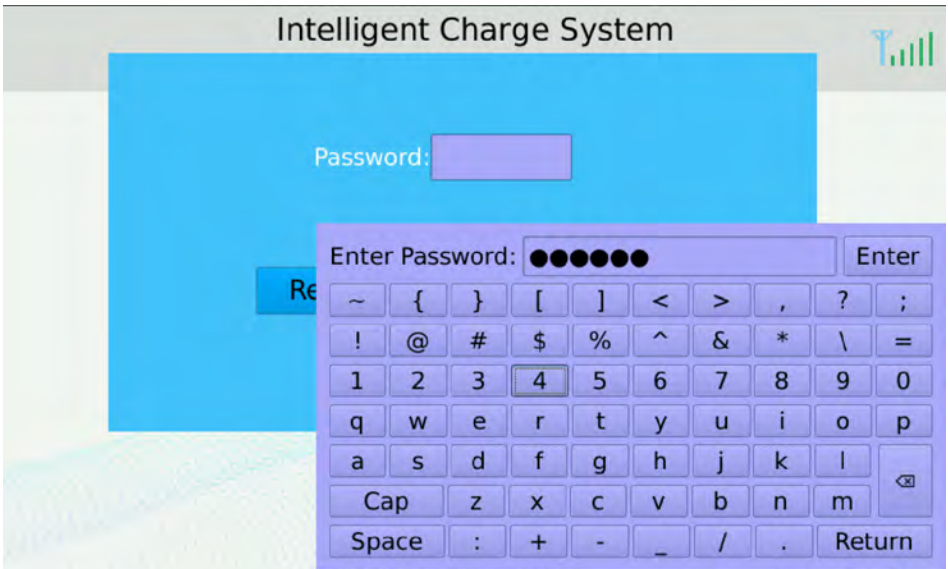

Click 'Charge Setting', select online in 'Authorize Mode', click 'Save' and wait for the device to restart.

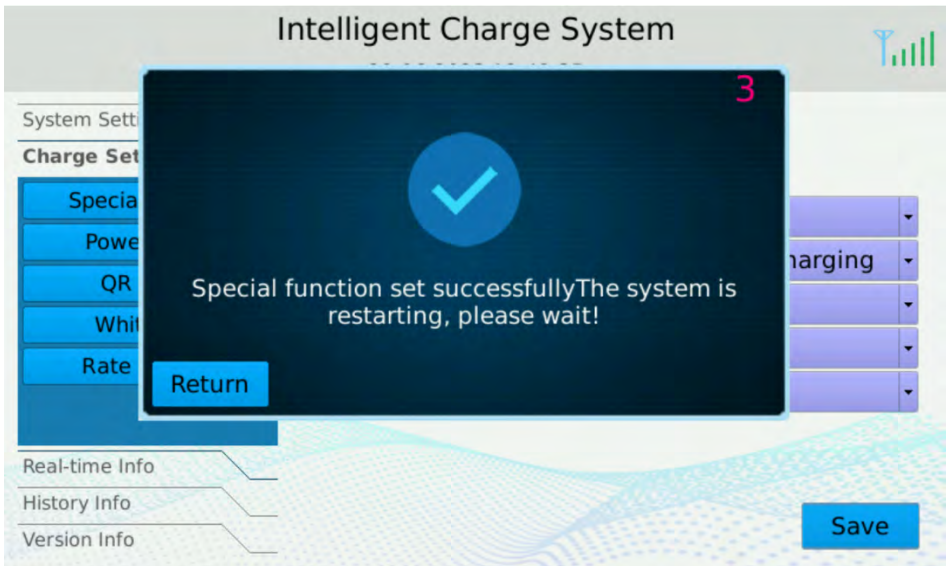

After restarting, Click on the blank space at the upper left of the screen, the login interface appears, enter the password '301204', click 'Enter', and click 'Login' to enter the settings main interface again.

Click “System Setting”, click “CSCU setting”, input the station number provided by the platform (if any), input the Platform Address of the platform. Click “Save”, the TCU set successfully and wait for the device to restart.

Choose static IP or DHCP as WAN type:

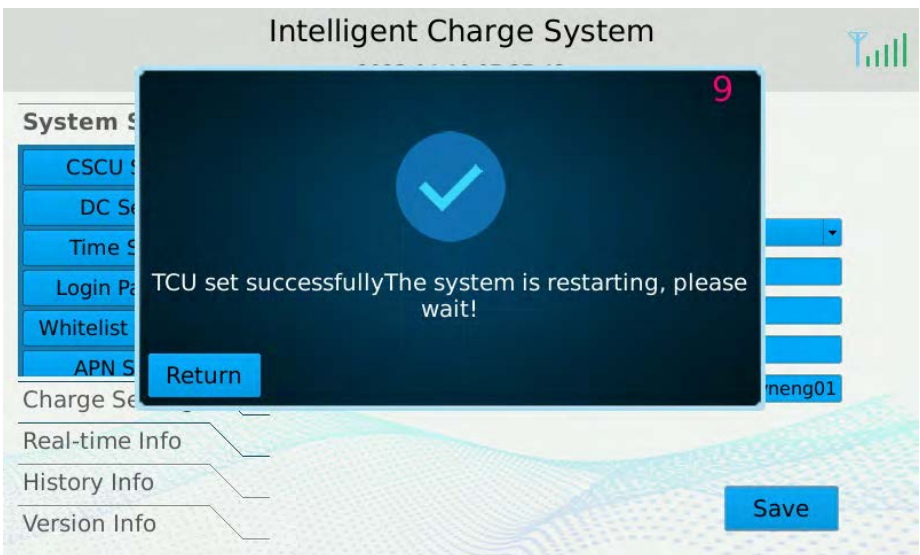
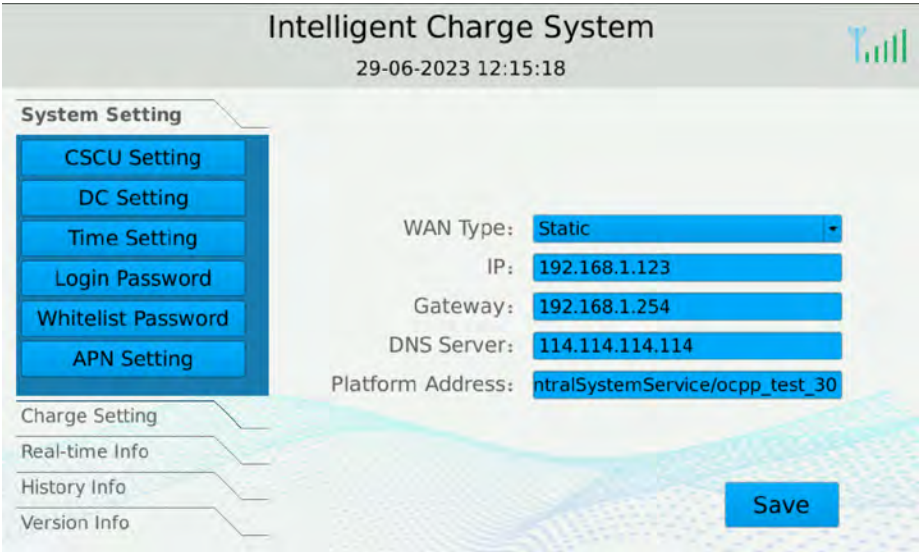

9. Decommissioning

Remove and dispose of the charging station in accordance with applicable local disposal regulations.





DANGER: Risk of electric shock

Before the charging station is removed, switch off all power at the power supply cabinet. Secure the power supply cabinet and put up warning signs to prevent accidental supply of power.

To remove Morek DC 30KW charging station, follow the installation steps listed above in reverse order.

Dispose of the charging station in a responsible manner.

	<p>Do not dispose of this charging station in household waste. Instead, dispose of this charging station at a local collection point for electric/electronic devices in order to enable recycling and thus avoid negative and hazardous environmental impact. Ask your city or local authorities for the address of your local facility.</p>
	<p>Recycling materials saves raw materials and energy, making a major contribution to conservation of the environment.</p>

10. Preventive Maintenance

For safe operation of the charger and to ensure a continuous and adequate level of service for users, regular maintenance and control of the equipment is required.

In addition to these regular maintenance operations, in case a fault or suspected fault, a corrective maintenance operation must be performed.

Below is the recommended preventive maintenance plan. If the operating environment is harsh (such as sandy environment, dusty environment, etc.), please shorten the maintenance cycle as appropriate.

Item	Period	Action
Air inlet filter	Every month	Clean
Power module fan	Every 6 months	Check and repair/replace if damaged
Power module	Every 3 months	Check and repair/replace if damaged
Charge cable	Every 6 months	Check and repair/replace if damaged
Cabinet appearance	Every 6 months	Check and repair/replace if damaged
Main control board	Every 6 months	Check and repair/replace if damaged
Display control board	Every 6 months	Check and repair/replace if damaged
Emergency stop switch	Every 6 months	Check and repair/replace if damaged
Display screen	Every 6 months	Check and repair/replace if damaged

Accident handling

Catastrophic accidents include charging equipment failures caused by lightning strikes, flooding, earthquakes, fires and other disasters. For disasters that may seriously affect safety, prevention should be the priority. At the same time, the charging station should have countermeasures and corresponding manpower and material resources to deal with these disasters, and should have emergency management regulations and major accident repair procedures.

It is recommended that when there is water immersion near the charging device, all switches inside the charging station should be disconnected, and the upstream power supply switch of the charging station should be disconnected to ensure the safety of personnel and prevent electric shock. The power module can be pulled out to minimize losses.

11. Troubleshooting

Fault	Analyze	Troubleshooting
AC contactor not contacting	Emergency stop button was pressed	Rotate and reset the emergency stop button
	The monitoring system detected there was a fault in the system and forced it to be disconnected	Find out the system fault
Cannot start charging	The input and output terminals of the charging module are not plugged in	Insert the charging module into place
	The charging gun not connected to the vehicle	Connect the charge cable to the vehicle and then start
	Cabinet door not closed	Restart after closing the cabinet door
	charging voltage mismatch	Please confirm whether the battery charging demand voltage matches the maximum output voltage of the charging station
	system error	Please check the fault code information and try again after troubleshooting
	Damaged charging module	Replace the charging module
	No charging modules in the charging station	Install the charging module
	Faulty communication cable of the charging module	Check the communication cable of the charging module
	Damaged output DC contactor	Replacing the DC Contactor
	DC fuse blows	Replace DC fuse; check DC output for short circuit fault
	Lightning arrester damage	Replacing the SPD
SPD fault alarm signal	Check whether the lightning protection fault alarm cable is properly connected	

	Damaged electricity meter	Replace the meter
	Monitoring unit failure	Replace the monitoring unit
	The front door or the left and right doors are not closed	Check whether the fault disappears after the front door or the left and right doors are closed
	The insulation of the positive or negative output of the charge gun and the ground is reduced	Use a multimeter to measure whether the impedance between the positive and negative columns of the DC output to PE is greater than 40K. If it is lower than this value, please troubleshoot or replace the charge cable.
	System over temperature protection	Check whether the air inlet and outlet of the system are blocked

Note: When the high-voltage power distribution of the upstream transformer of the charging equipment is cut off, the MCB Q1 in the charging equipment should be disconnected immediately to prevent the voltage shock causing damage to the charging equipment after the high-voltage power distribution of the upstream transformer is restored. damage. Please wait for the high voltage distribution of the upstream transformer to be restored before restoring the power supply to the charging equipment

