

MOREK

Creating a better future for You



***Morek EV AC Charger
Installation and User Manual***

ev.morek.eu

Not just for private use – find a suitable model and service for an apartment building, parking lot, commercial building, etc.

Smart charge (WiFi, LAN, and/or optional 4G)

Use it at a private house, apartment building, or work. Charge and share chargings. Perfect for public charging with Powered by Vonktech charge point & payment platform.

Plug & charge

For private use. No internet connection and smart features. Just plug & charge.



***Network charger
3.8 " LCD display
LAN, WiFi, RFID
5m cable
Type 2 connector***



***Network charger
3.8 " LCD display
LAN, WiFi, RFID
Type 2 socket***



***Plug & Charge
LED indicator
5m cable
Type 2 connector***



The installation process is simplified for maximum efficiency. The charger comes with a preset configuration and easy access with the Morek EV Tool APP to reduce setup time.







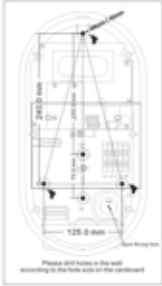
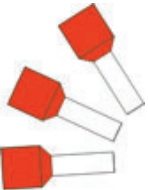

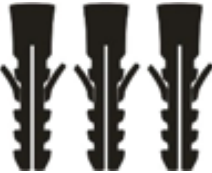
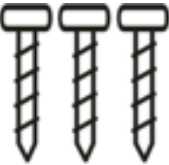

Contents

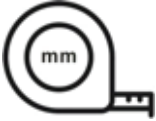
<i>Whats included in the box</i>	2
<i>Required tools for installation</i>	3
<i>Installation steps</i>	5
<i>User interface</i>	7
<i>Charging operations</i>	8
<i>Display description</i>	9
<i>Plug&Charge model downgrade</i>	13
<i>LED indicator</i>	14
<i>Troubleshooting</i>	15
<i>Maintenance</i>	16
<i>Safety notes</i>	17

Whats included in the box

<p><i>Installation template</i></p>  <p>The diagram shows a technical drawing of a rectangular installation area on a wall. It includes dimensions for the overall area and the mounting holes. A note at the bottom reads: "Please drill holes in the wall according to the hole size on the cut sheet".</p>	<p><i>Insulated cord end terminals</i></p>  <p>Three red, rectangular, insulated cord end terminals with white plastic bases.</p>	<p><i>Waterproof gaskets</i></p>  <p>Three circular, white, waterproof gaskets with a central hole.</p>
<p><i>8 x 40 mm wall plugs</i></p>  <p>Three black, cylindrical wall plugs with a central hole and a flared base.</p>	<p><i>5 x 40 mm screws</i></p>  <p>Three black, cylindrical screws with a flat head and a threaded shaft.</p>	

Required tools for installation

<p><i>Measuring tape</i></p> 	<p><i>Electric drill</i></p> 	<p><i>Hammer</i></p> 
<p><i>Slotted screwdriver</i></p> 	<p><i>Phillips screwdriver</i></p> 	<p><i>Wire stripper</i></p> 
<p><i>Utility knife</i></p> 	<p><i>8mm drill bit</i></p> 	

Installation steps

Cut the drilling template from the carton, place the drilling template on the wall, drill holes where the three fixing points, insert the Wall plugs into the fixing holes.

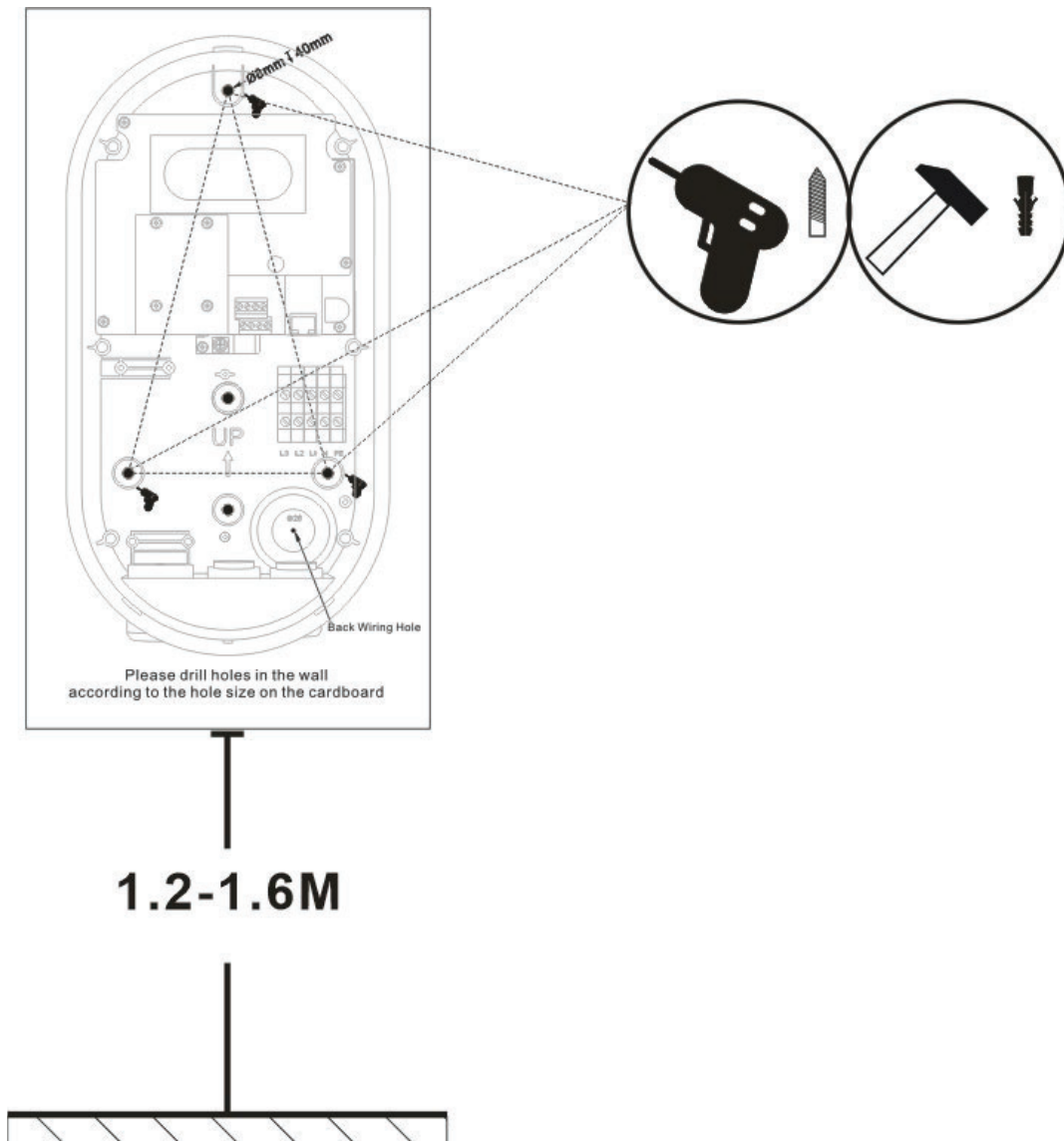

Installation steps

Open the cover

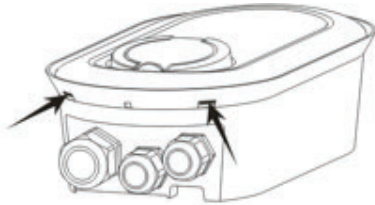

Press the two barbs under the machine and take out the decorative cover.

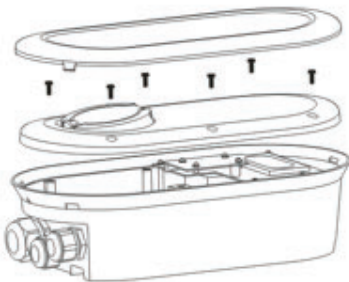

Loosen the six screws of the cover and take out the cover.

Fix the device on the wall by inserting the screws and waterproof gaskets

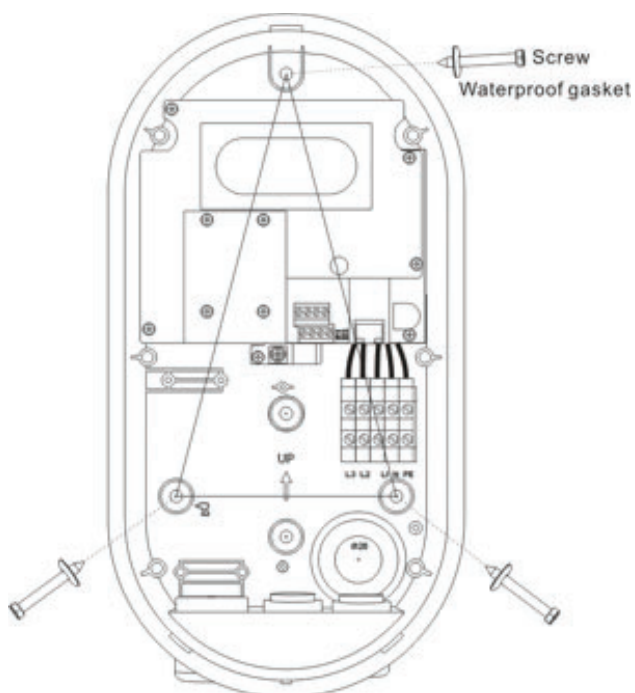

Installation steps

Wiring diagram, Electrical Wiring

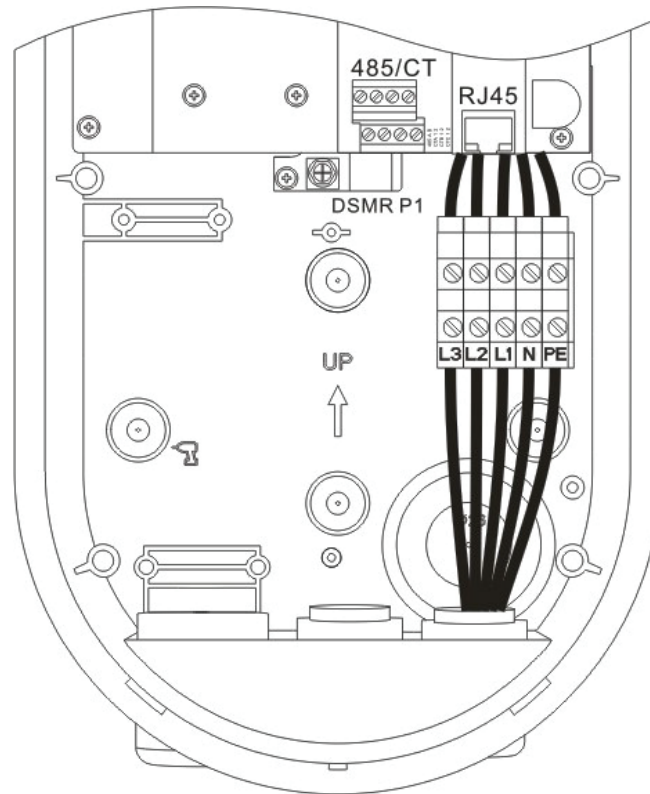

Put back the cover. Screw back the cover screws Buckle the upper cover.

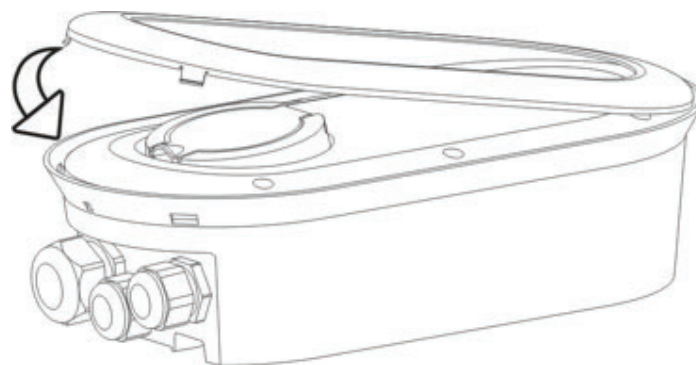

Operation - User Interface

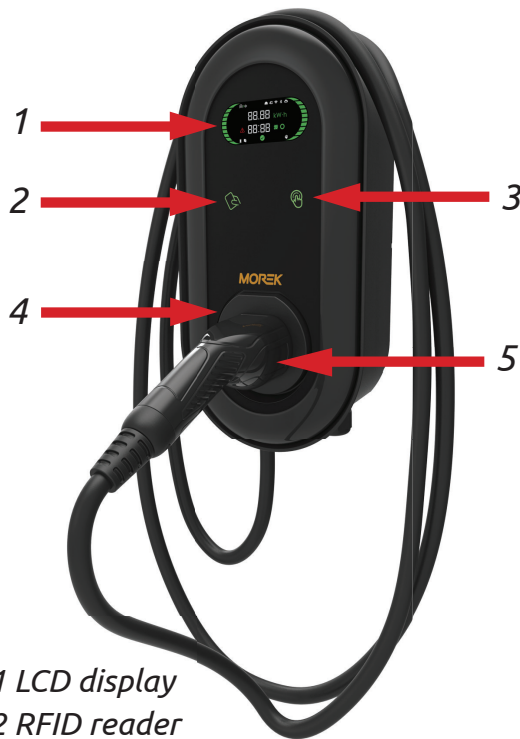

- 1 LCD display
- 2 RFID reader
- 3 Button
- 4 Connector holder
- 5 Type 2 plug

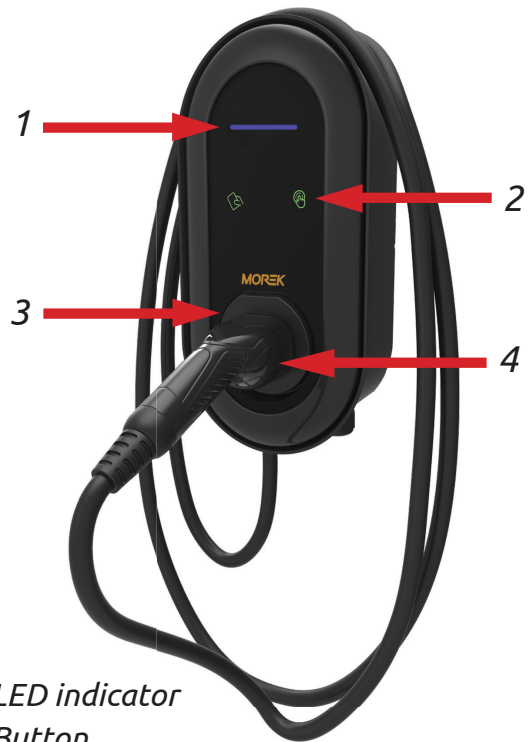

- 1 LED indicator
- 2 Button
- 3 Connector holder
- 4 Type 2 plug



- 1 LCD display
- 2 RFID reader
- 3 Button
- 4 Type 2 socket

Operation - Charging operation

Powered by Vonktech

The charger is by default connected to the Vonktech OCPP backend server and system. This will provide some extra functionalities for the charger owner but free of charge is the possibility to start and stop the charger remotely. For extra functionalities and prices, please see the Morek Powered by Vonktech pricelist.

Charging the EV

- *Connect EV*
- *When the charger status is available or prepare, start charging from the APP*
- *Stop charging from APP*
- *Disconnect EV*

RFID only Mode

To start charging:

- *Connect EV*
- *Tap the RFID card in the RFID reader area.*

To stop charging

- *Tap the RFID card in the RFID reader area.*
- *Disconnect EV*

Plug and Charge Mode

To start charging:

- *Connect EV*

To stop charging:

- *Press the touch button*
- *Disconnect EV*

Display description

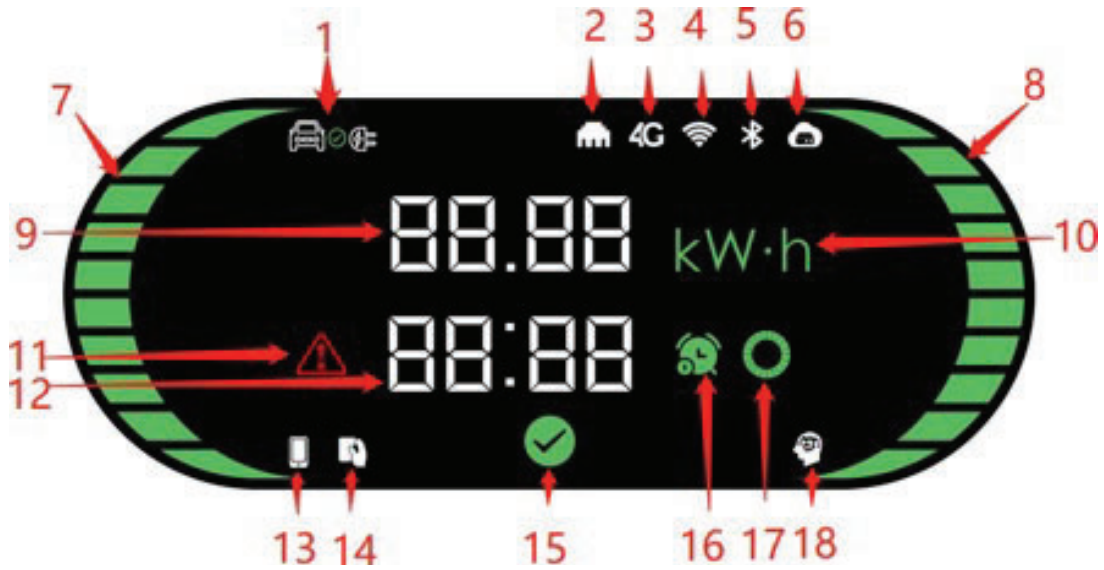

- | | |
|-----------------------------------|--------------------------------|
| 1 EV connection | 10 Energy/Power unit |
| 2 LAN | 11 Fault indicator |
| 3 4G | 12 Time or fault code |
| 4 WiFi | 13 Mobile APP control |
| 5 Bluetooth | 14 RFID control |
| 6 CMS | 15 Available indicator |
| 7 Left status bar | 16 Reservation time indication |
| 8 Right status bar | 17 Waiting indicator |
| 9 Energy, power, or rated current | 18 Smart Charger indicator |

Availability - charger status Available

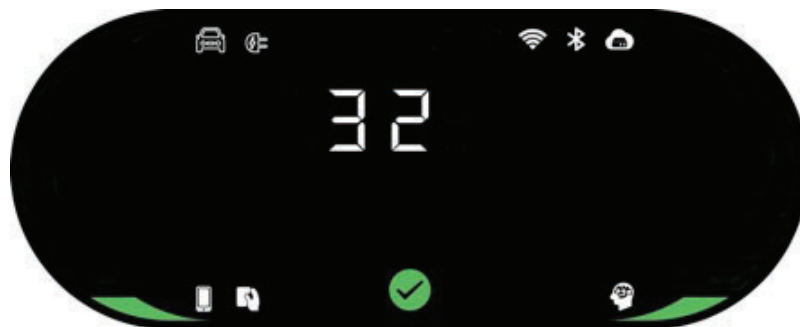

Not connected to EV
 Display rated current (A)
 One left and right status bar indicates a single-phase charger
 Three left and right status bars indicate a three-phase charger

Display description

Preparing- charger status Preparing

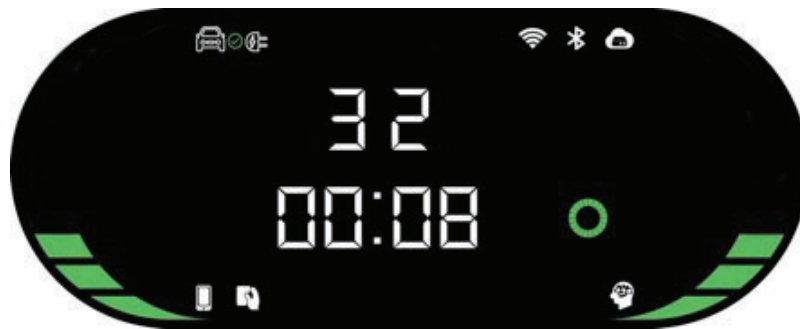

*Start charging
Display rated current (A)
Display time (minutes)*

Charging- charger status Charging

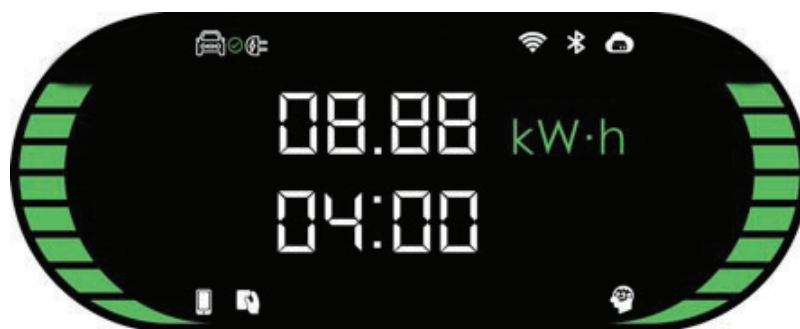

*Display charging power (kW), charging energy (kWh) in turn
Display charging time (minutes)
The left and right status bars indicate charging*

Display description

Suspended- charger status SuspendedEV

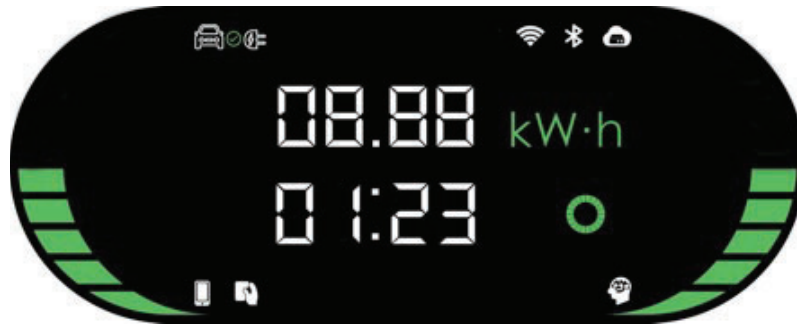

*Charging suspend
Display charging energy (kWh)
Display charging time (minutes)
Display Waiting indicator*

Finished- charger status Finished

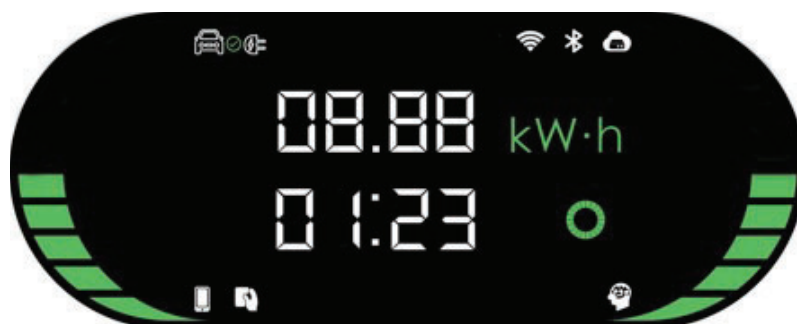

*Charging has ended
Display charging energy (kWh)
Display charging time (minutes)*

Display description

Reservation - charger status Reserved

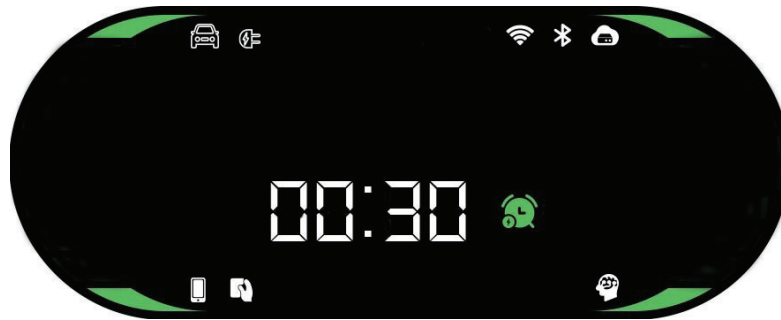

*Reserved charging
Display Reservation time (minutes)*

Finished- charger status Finished

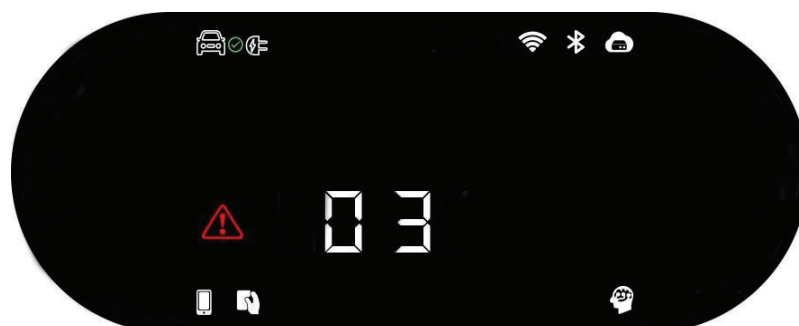

*Fault
Display fault code, for the meaning of the fault*

- see Troubleshooting

Plug&Charge model power downgrade

As the Plug&Charge models have no communication possibilities the downgrade of these models is possible either through a DIP switch or just wiring the 3 phase charger to 1 phase.



Locate and change the output power

The DIP switch is located under the LED panel, just above the LAN network port, inside the charger. To get to the switch please remove the front cover from the charger and locate the switch as shown in the picture.

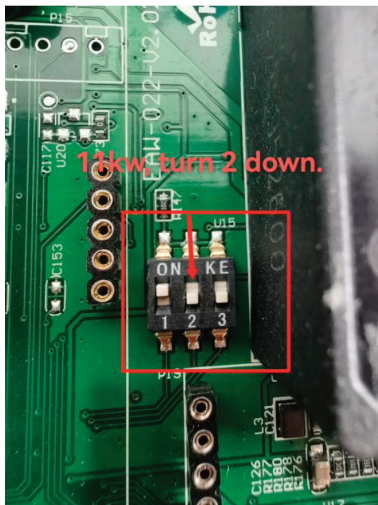

To change the output power from 22kW to 11kW push the second switch down.

To change the output power from 11kW (or 22kW) to 7,4kW just install the charger to 1 phase electrical connection.

On 1 phase current the charger's maximum output power is 32A. To change it to 16A, please use the second switch on the DIP switch.

LED indicator

Light Status	Description
Solid Yellow	APP Mode: not connected to EV and not connected to the backend
Solid Green	APP Mode: not connected to EV but connected to the back end RFID or Plug&Charge Mode: not connected to EV
Blue Twinkle	Connected to EV
Green Twinkle slowly	Reservation in progress
Blue streaming	Charging
Blue Twinkle	Charging finished
Solid Red	Unavailable
Red Twinkle fast	Firmware update
RED flashes 1 time	Fault: fault code 1
RED flashes 2 times	Fault: fault code 2
RED flashes 3 times	Fault: fault code 3
RED flashes 4 times	Fault: fault code 4
RED flashes 5 times	Fault: fault code 5
RED flashes 6 times	Fault: fault code 6
RED flashes 7 times	Fault: fault code 7

Troubleshooting

fault code	Fault description	Troubleshooting suggestion
1	Leakage	<ul style="list-style-type: none"> • Check whether the charging connector and its cable are damaged or wet. • Recover after pulling out the adapter.
2	Over Current	<ul style="list-style-type: none"> • Check whether the charging connector is correctly connected • Check whether the OBC is normal.
3	Ground disconnected	<ul style="list-style-type: none"> • Charging station is not grounded; input power cable needs to be checked.
4	Overtoltage or undervoltage	<ul style="list-style-type: none"> • Check whether the input cable connection is reliable. • Check whether the input voltage is abnormal.
5	Contacting welding or breaking	<ul style="list-style-type: none"> • Check whether the contactor connection is reliable.
6	CP abnormal	<ul style="list-style-type: none"> • Check the charging connector and charging socket of EV. • Disconnect and reconnect the charging connector.
7	Electronic lock fault	<ul style="list-style-type: none"> • Check that the electronic lock connection is reliable.

Maintenance

To ensure the long-term stable operation of the equipment, please maintain the equipment regularly (usually every month) according to the operating environment.

- a) The equipment is maintained by professionals.*
- b) Check whether the equipment is well grounded and safe.*
- c) Check whether there are potential safety hazards around the charging pile, such as whether there are high temperature, corrosion or inflammable and explosive articles close to the charging station.*
- d) Check whether the join point of the input terminal is in good contact and whether there is any abnormality.*

Check whether other terminal points are loose

Please read carefully to understand the correct use of the device before installation, maintenance, and operation!

Please follow the safety notes; otherwise, it may lead to a danger of death, injury and damage to the device, supplier cannot accept any liability for claims resulting from this.

• This manual describes the installation, use and maintenance of AC Charger. This manual is intended for installation and maintenance personnel.

• The text and illustrations in this user manual are general explanations of these type of equipment, and the actual product may be inconsistent with this manual in detail.

Safety notes

Leave no inflammable or explosive substances near the EV Charger; otherwise, hazardous blast may result.

Installation and wiring should be done by personnel with professional qualifications, otherwise, a hazardous electric shock may result.

Make sure input power supply is entirely disconnected before wiring; otherwise, hazardous electric shock may result.

Earth terminal of the EV Charger must be grounded securely; otherwise, hazardous electric shock may result.

The lead nose of the charger must be securely attached or there is a risk of damaging the equipment.

Leave no metals such as bolts, gaskets into the inside of the EV Charger; otherwise, hazardous blast and fire may result.

Strictly forbidden for minors or persons of restricted capacity to approach the charger to avoid injury.

Forced charging is strictly forbidden when the electric vehicle or charger fails.

It is strictly prohibited to use the charger when the charging adapter or charging cables are defective, cracked, worn, broken or the charging cables is exposed. If you find any, please contact the supplier in time.

EV can only be charged with the engine off and stationary.

Accessory replacement must be done by qualified personnel, thrums or metals are prohibited to be left in the controller; otherwise, hazardous blast and fire may result.

It is recommended that routine safety inspection visits to charger be conducted at least once a week.

Keep the charging connector clean and dry and wipe with a clean, dry cloth if soiled.

Manage chargings the easy, effective, and versatile way

Manage electric car charging locally or in various locations across Europe from one system.

Morek AC chargers can be installed either on a wall or pole which enables infrastructure planning for indoor or outdoor parking spaces more flexible.



Morek Finland



Morek Estonia



Morek Latvia



Morek Lithuania



Morek Poland



Morek Czech Republic



Morek Slovakia



Morek France



Morek Bulgaria



Morek Portugal

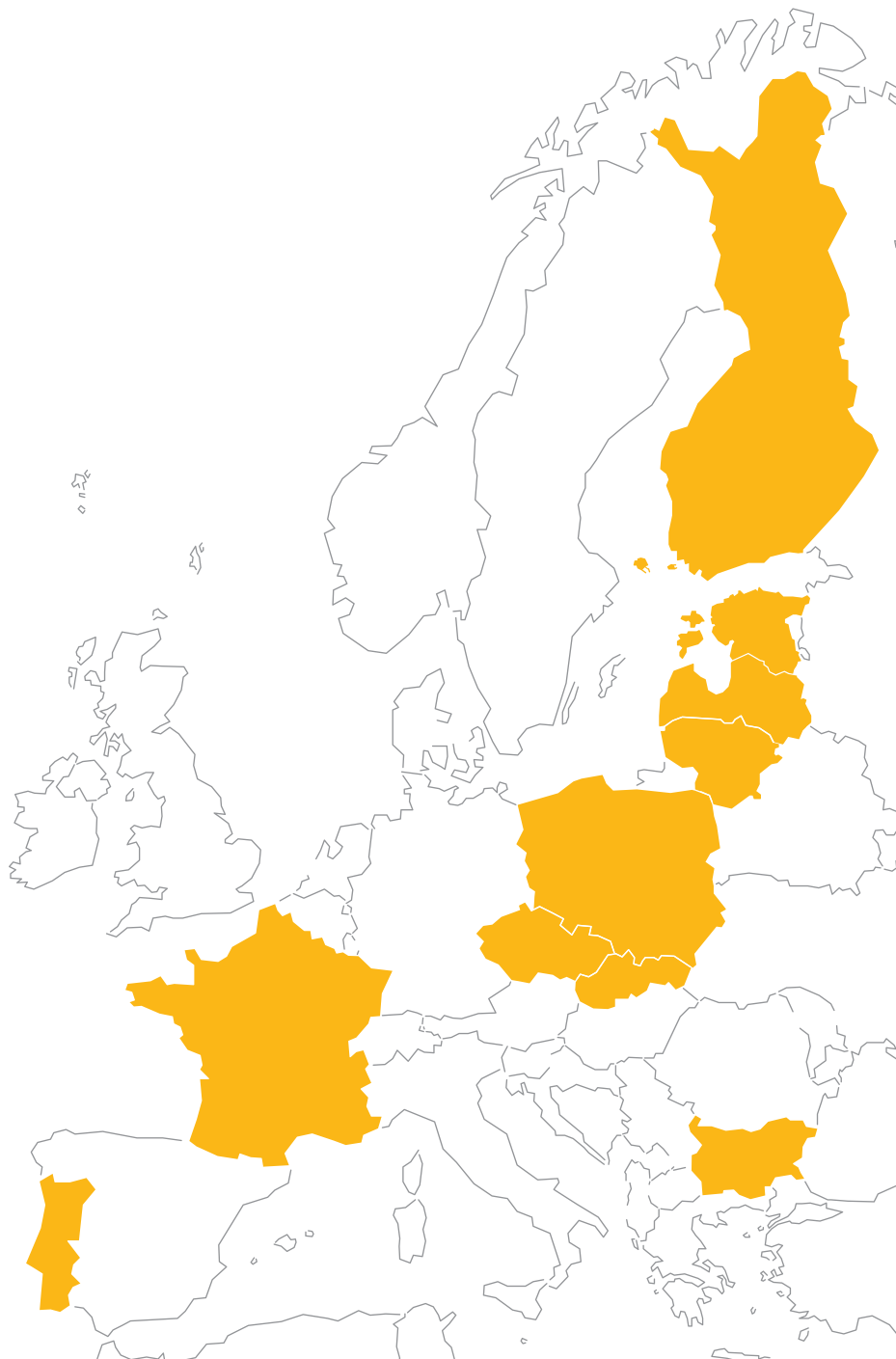

Questions? Make us work harder!

More information about Morek EV chargers and discussions about EV user cases can be found from ev.morek.eu

